

урам 2  
грамме 2  
аграмма 2

Л/а  
Ди  
Ди:

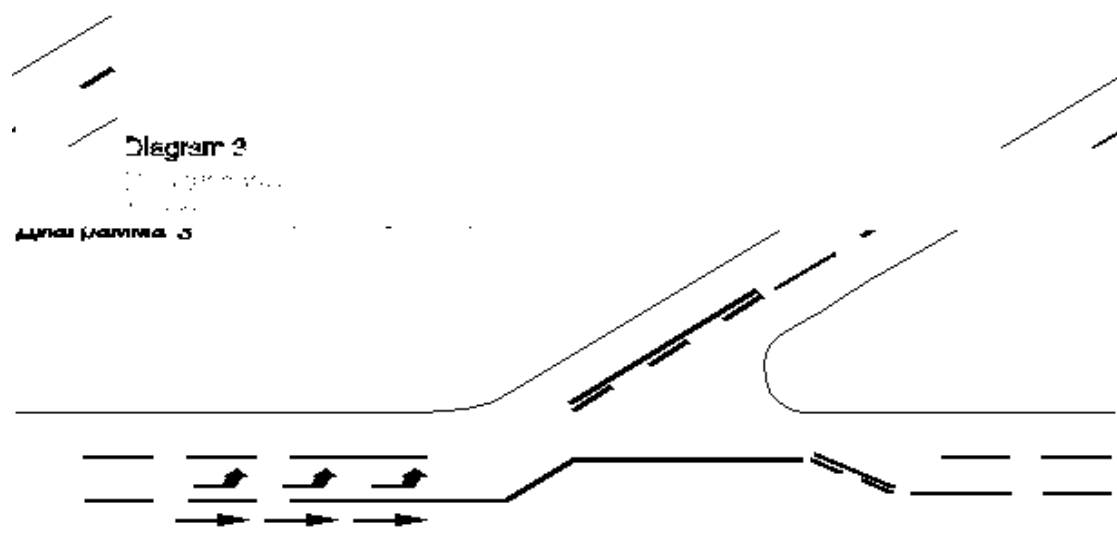
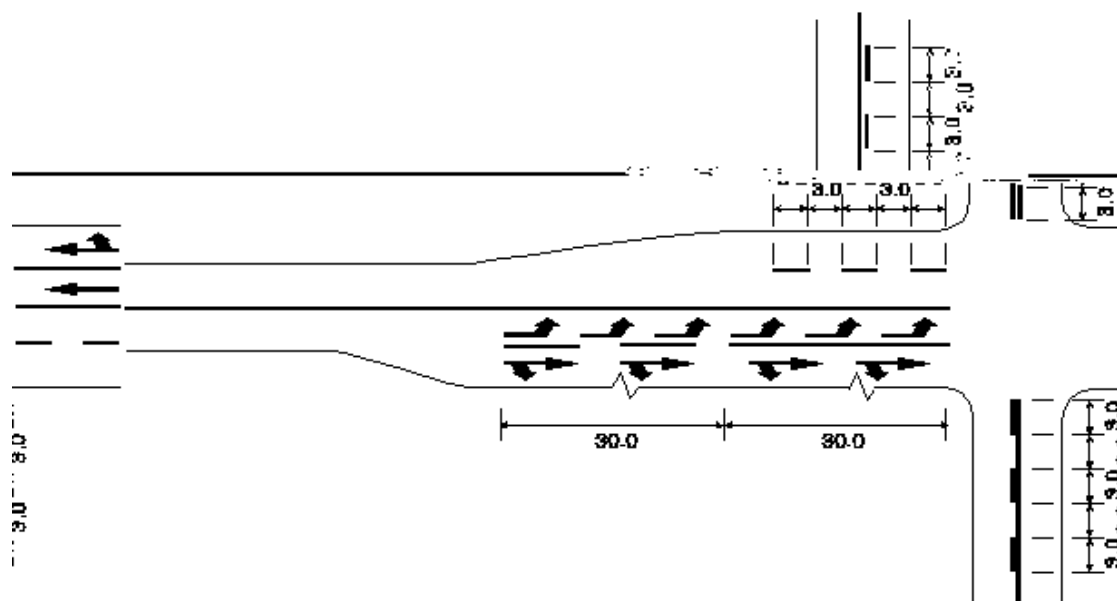


Diagramme 4  
Диаграмма 4

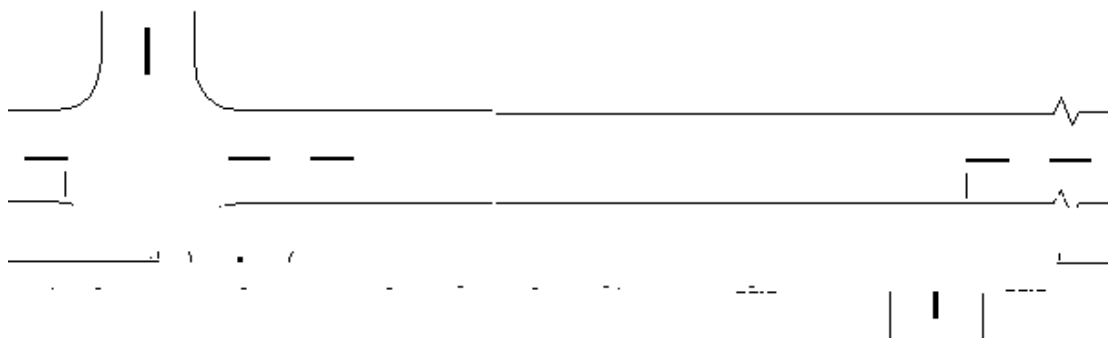


Diagram 5  
Diagramme 5  
Диаграмма 5

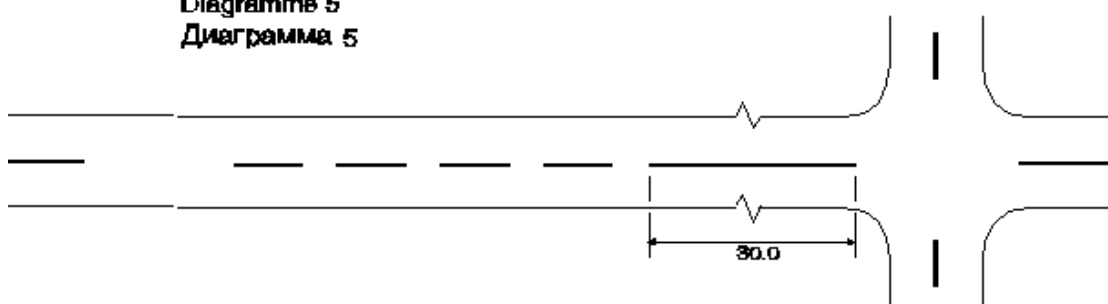
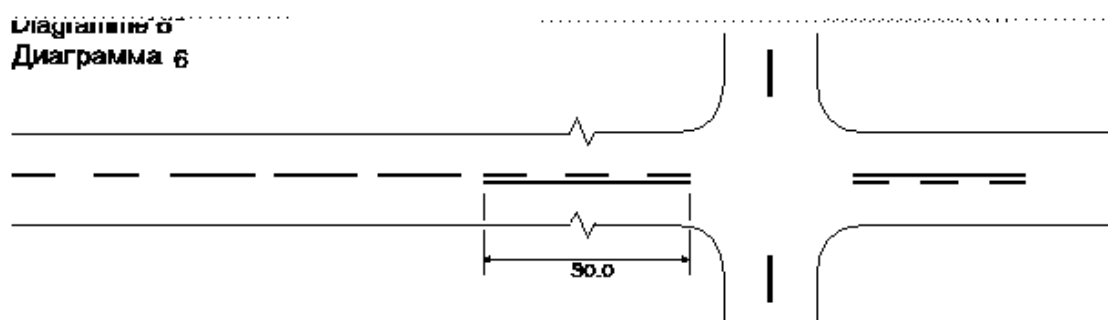
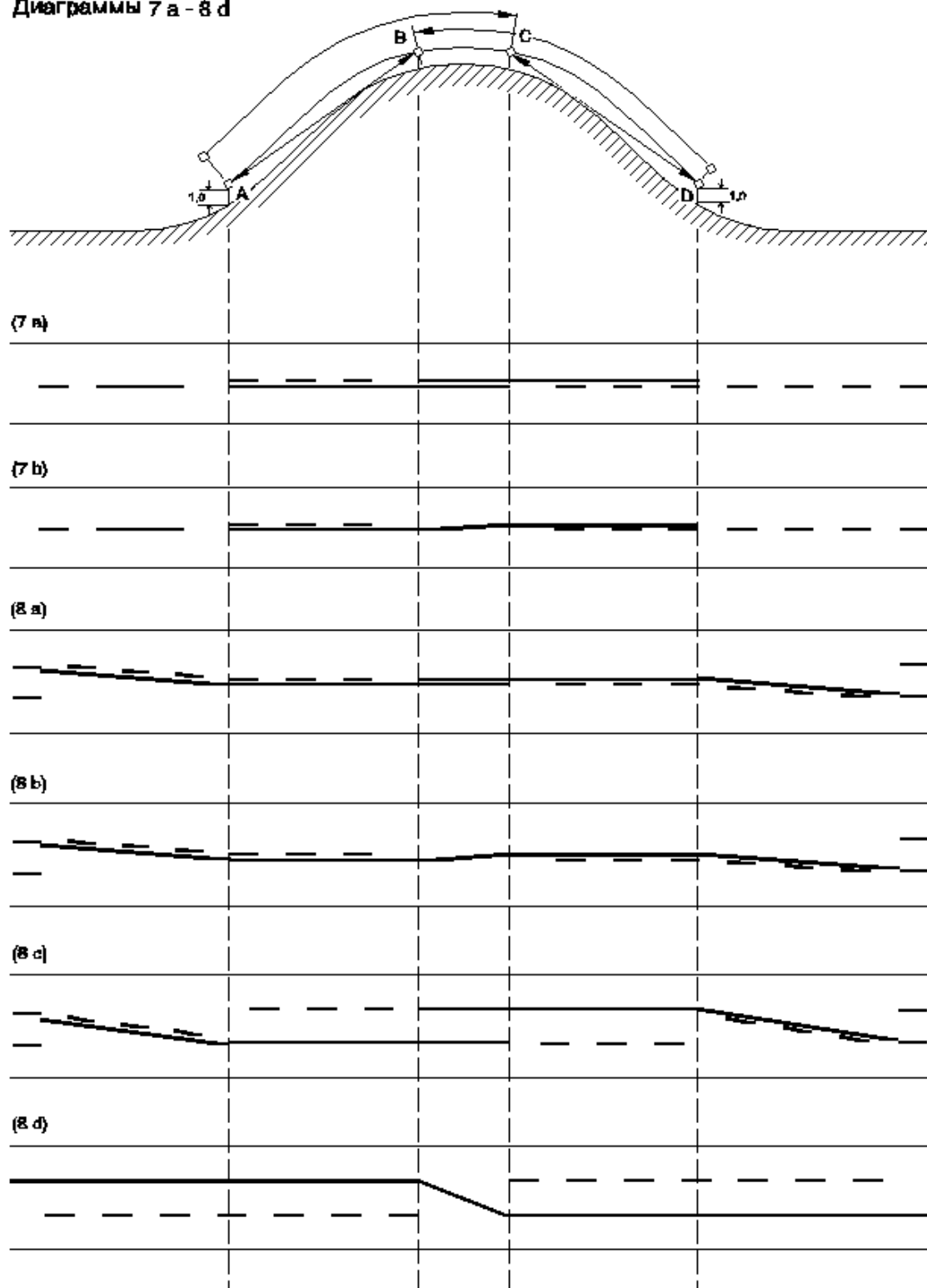


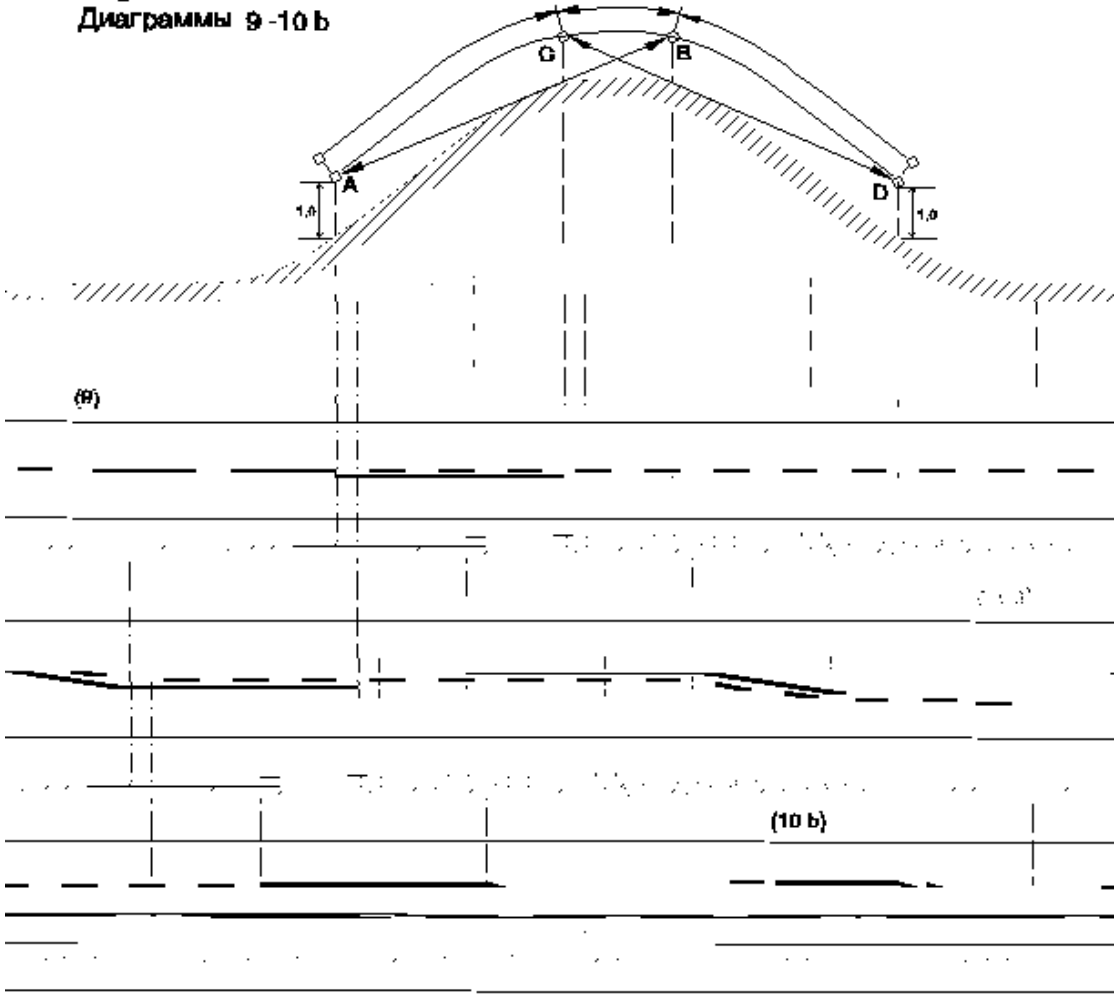
Diagram 6



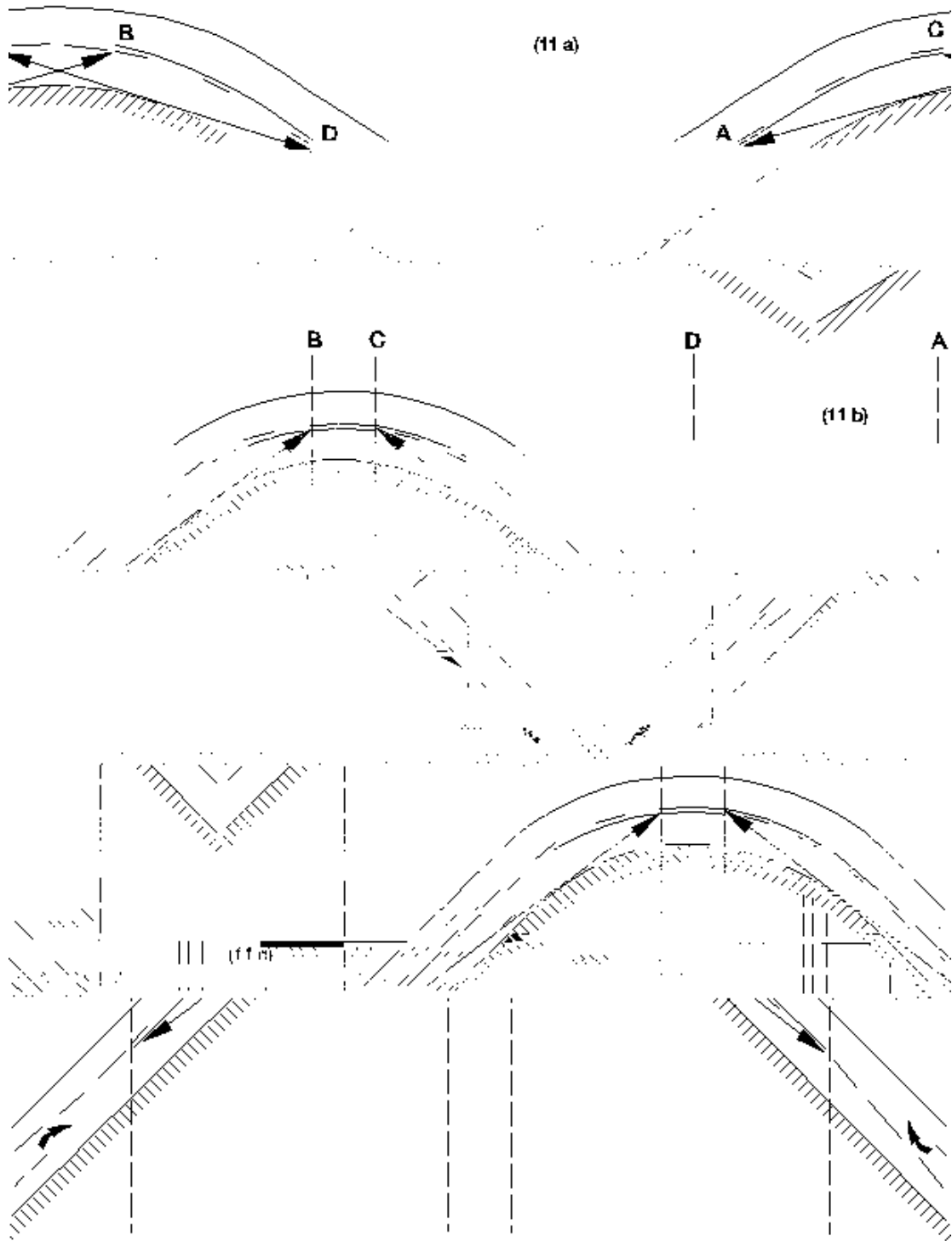
Diagrams 7 a - 8 d  
 Diagrammes 7 a - 8 d  
 Диаграммы 7 а - 8 d

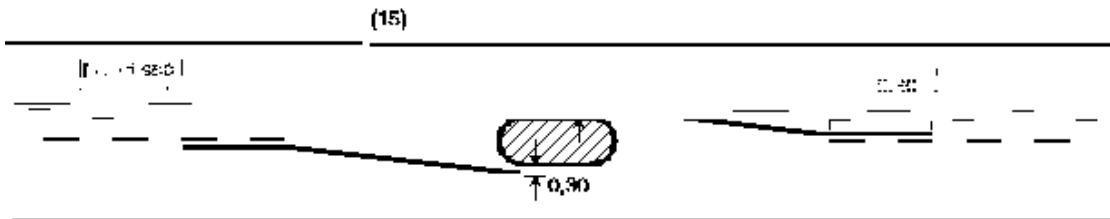
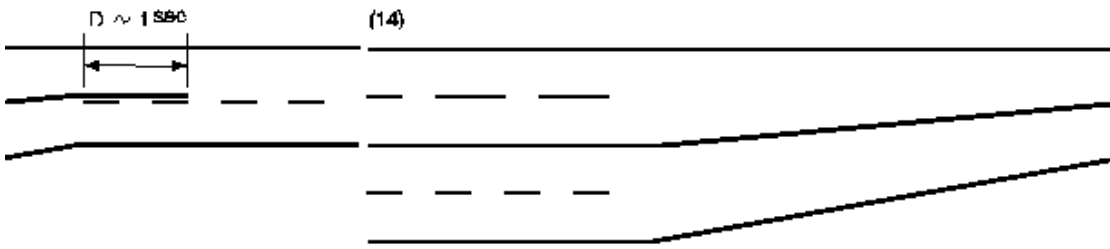
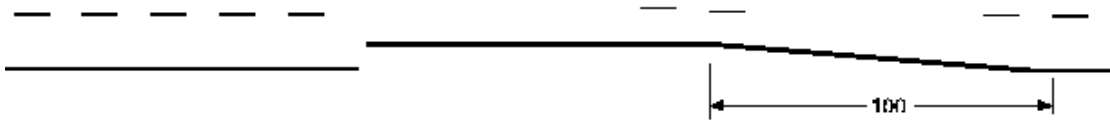
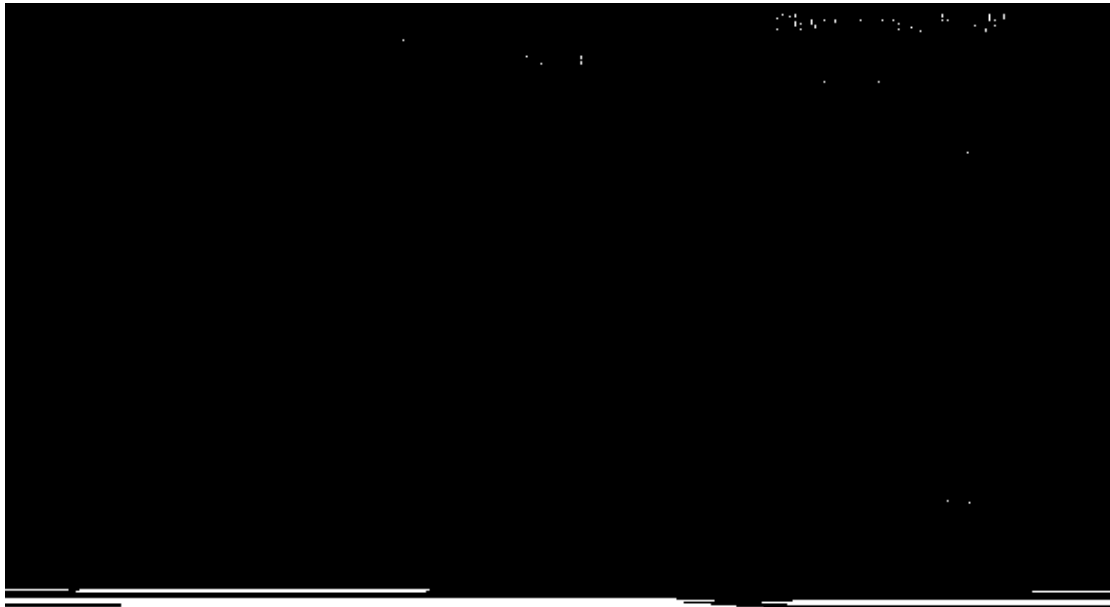


Diagrams 9-10 b  
Diagrammes 9-10 b  
Диаграммы 9-10 b



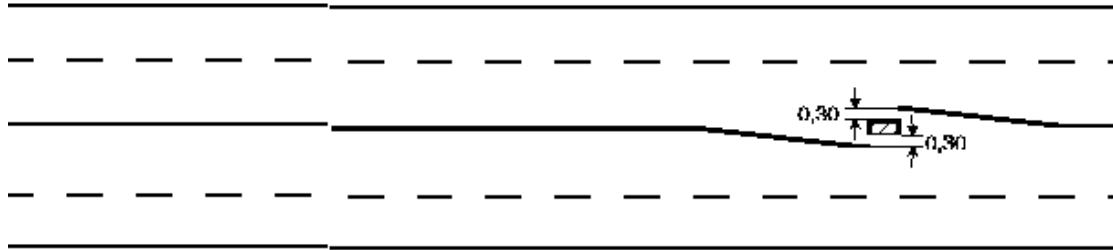
Diagrams 11 a -11 c  
Diagrammes 11 a -11 c  
Диаграммы 11 а -11 с



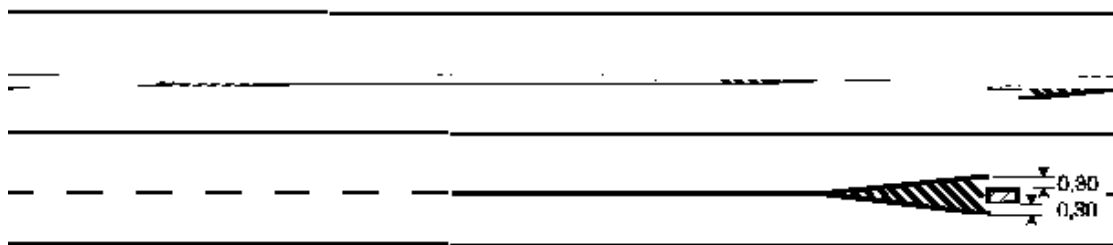


Diagrame 16-18  
Diagrammes 16-18  
Диаграммы 16-18

(16)



(17)



(18)

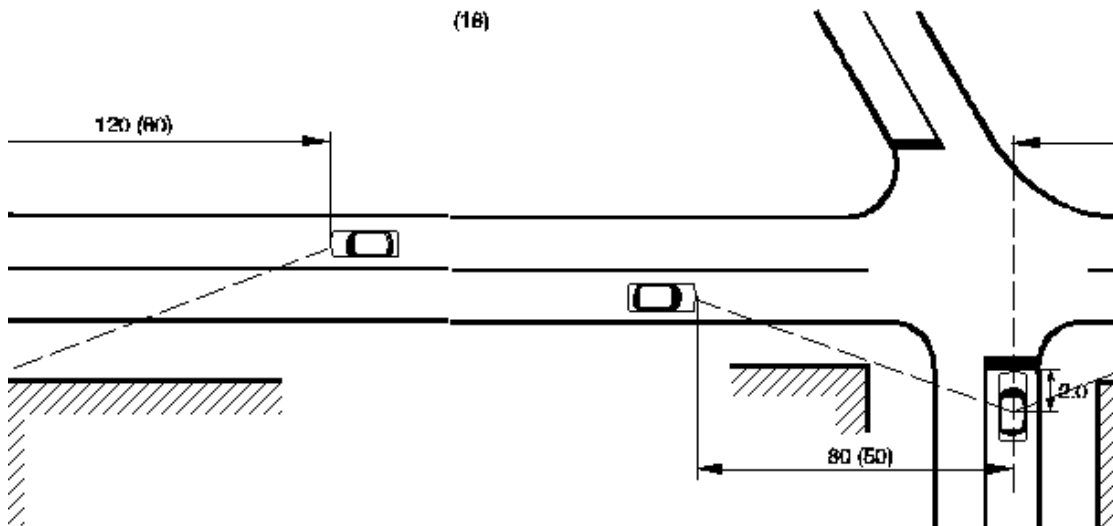


Figure 1  
Schematic diagram

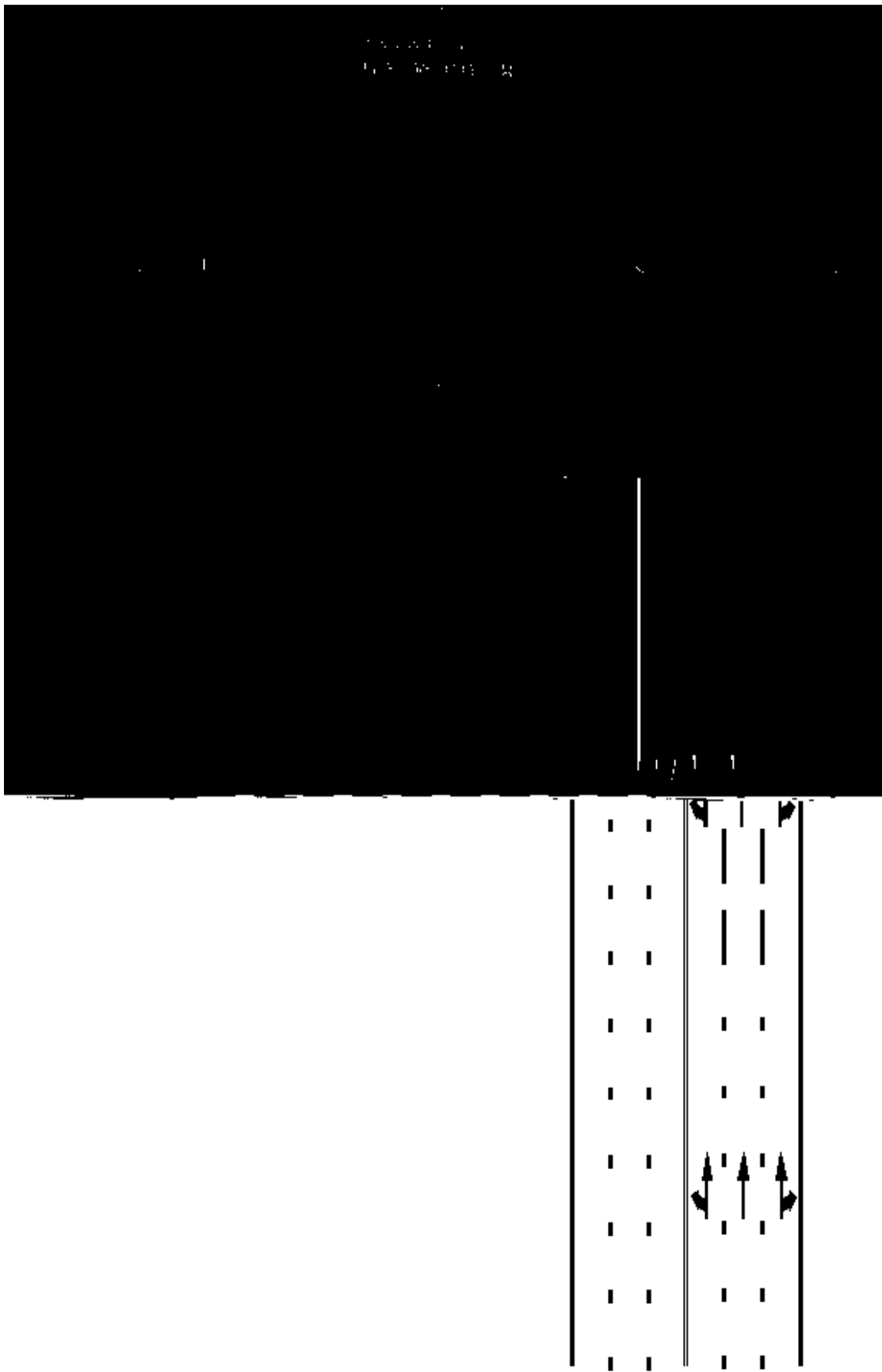




Diagramme 20  
 Diagramma 20

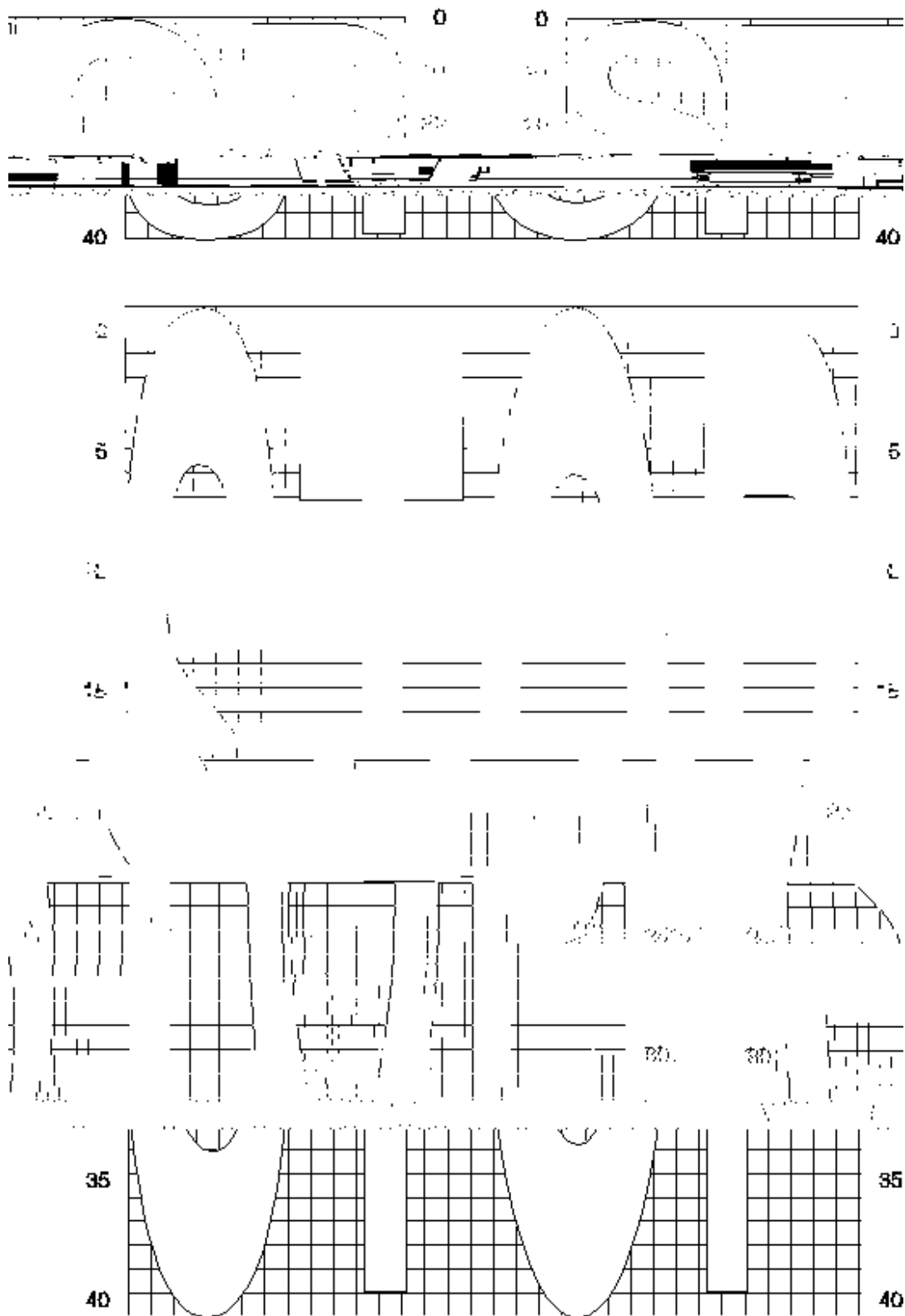
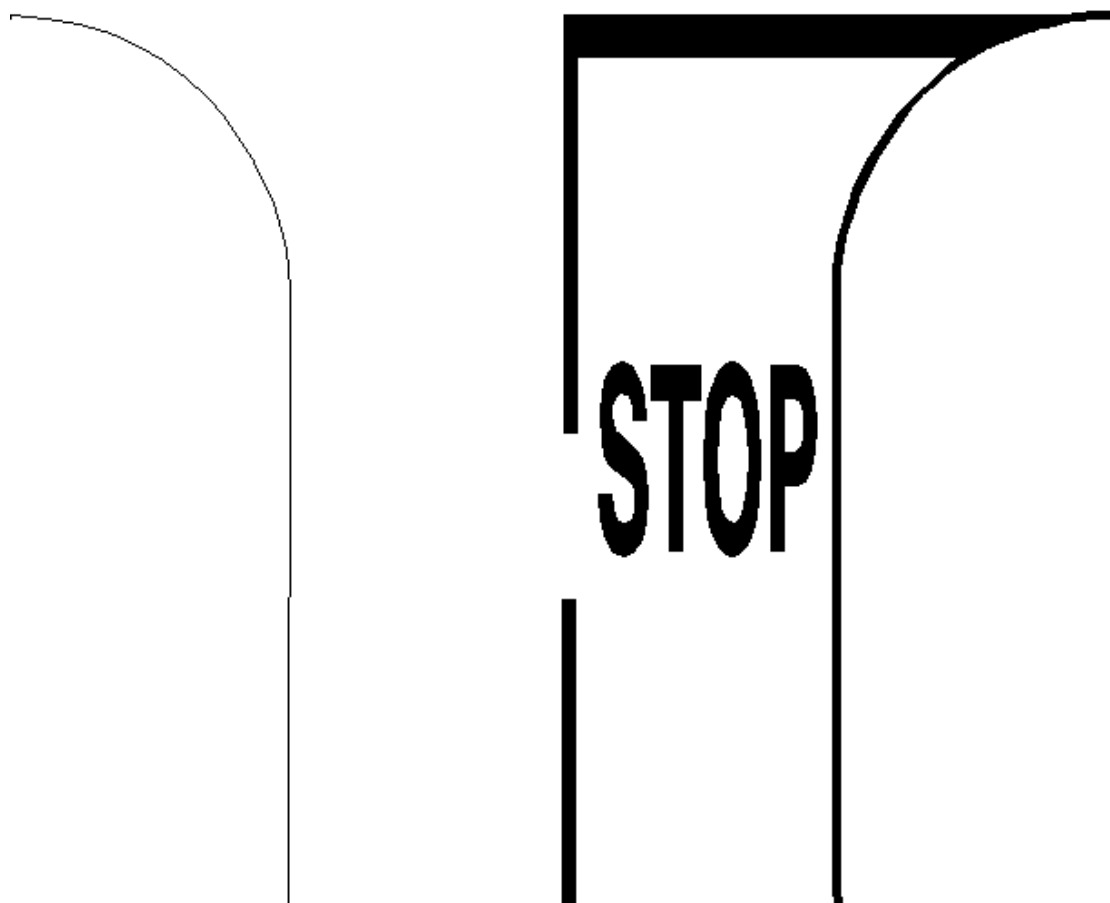


Diagram 21  
Diagramme 21  
Диаграмма 21



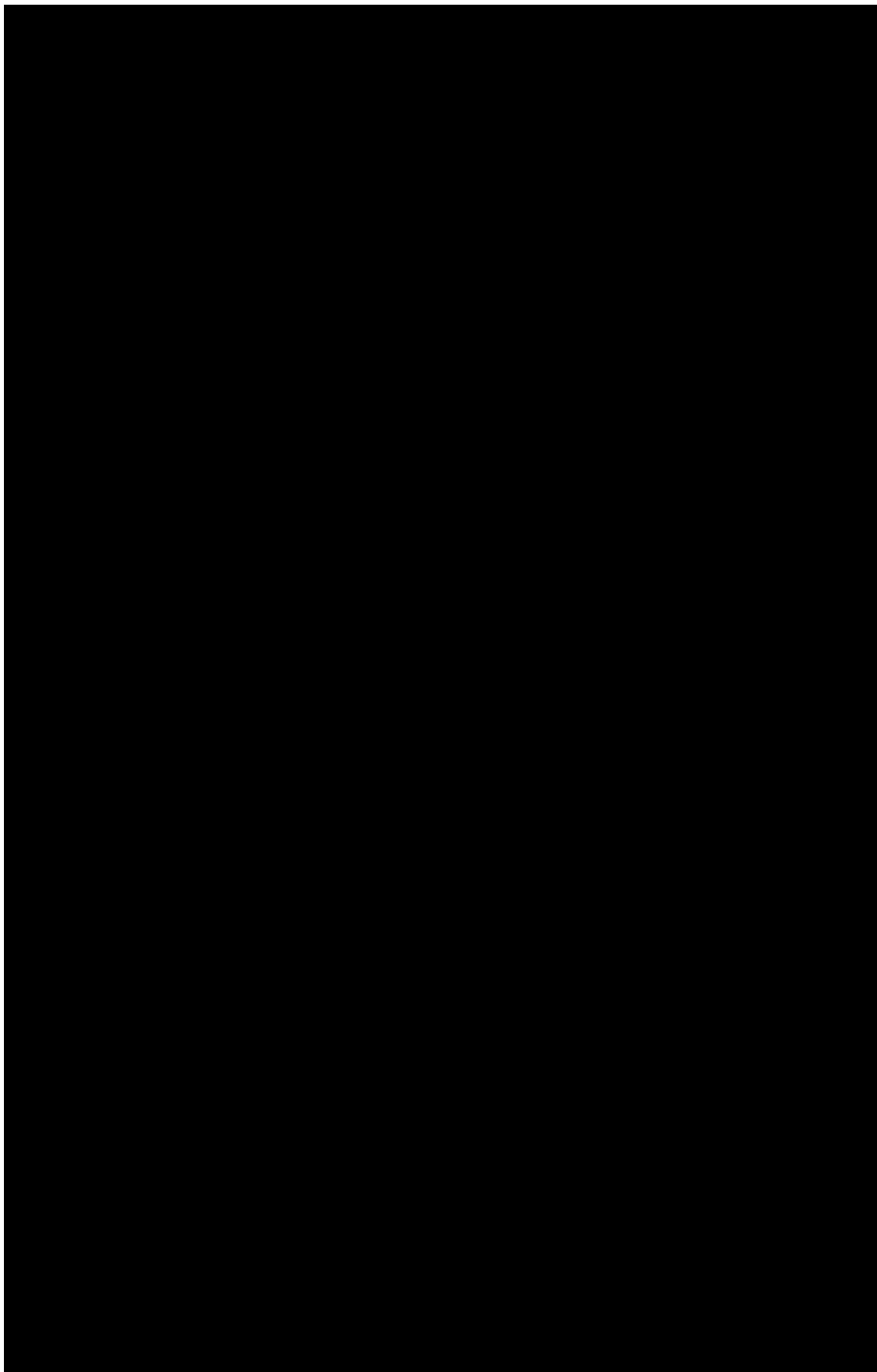
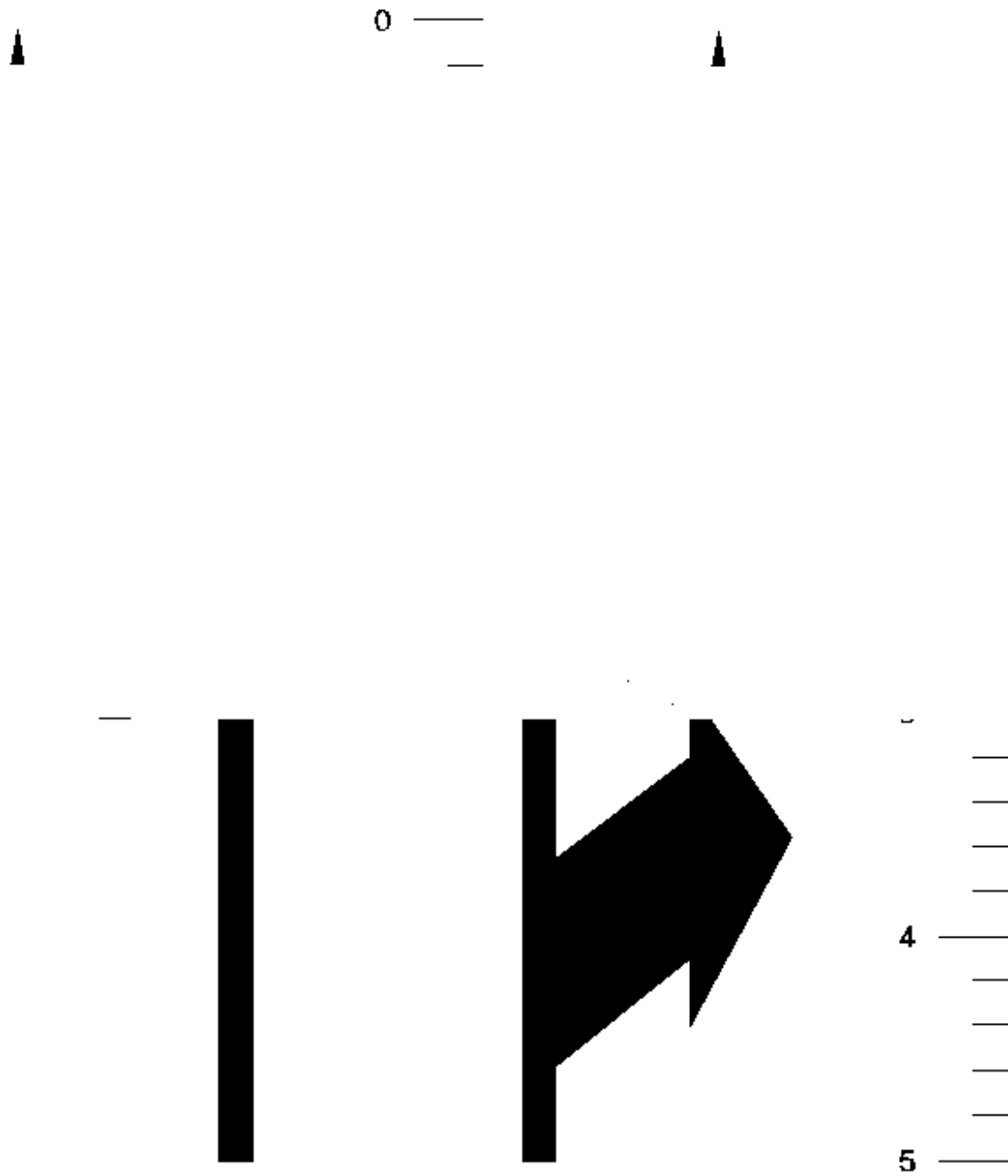
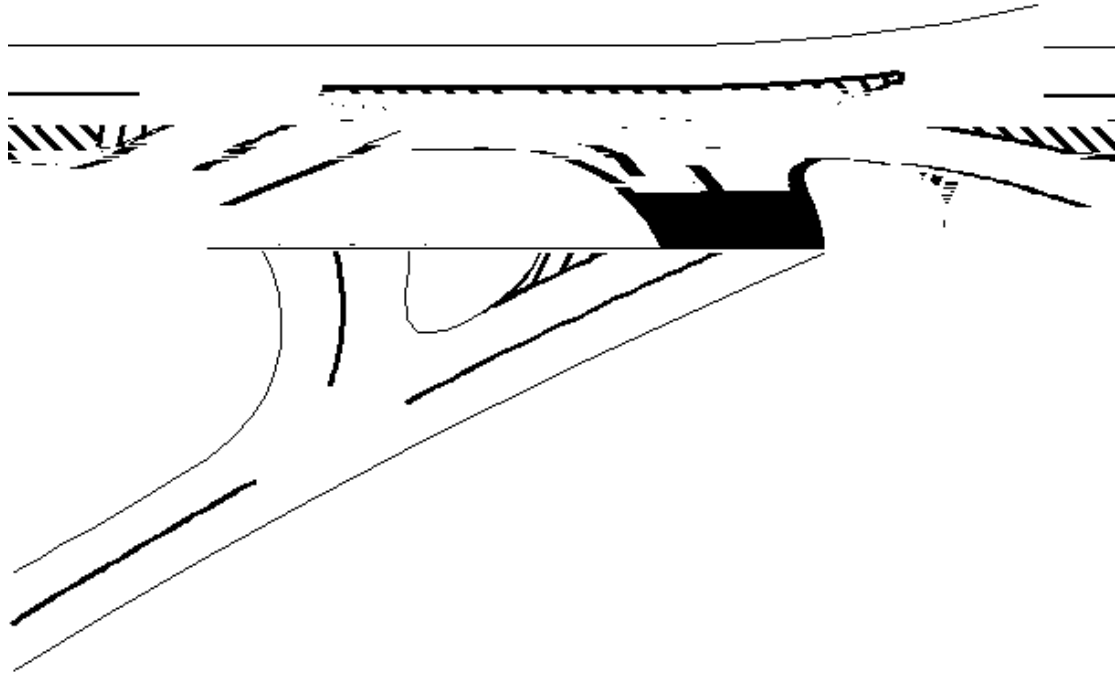
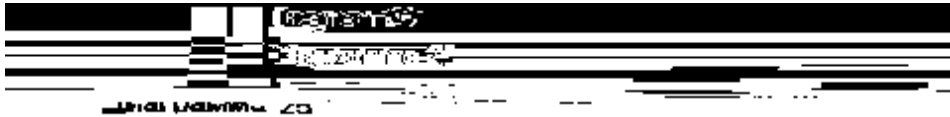


Диаграмма 23



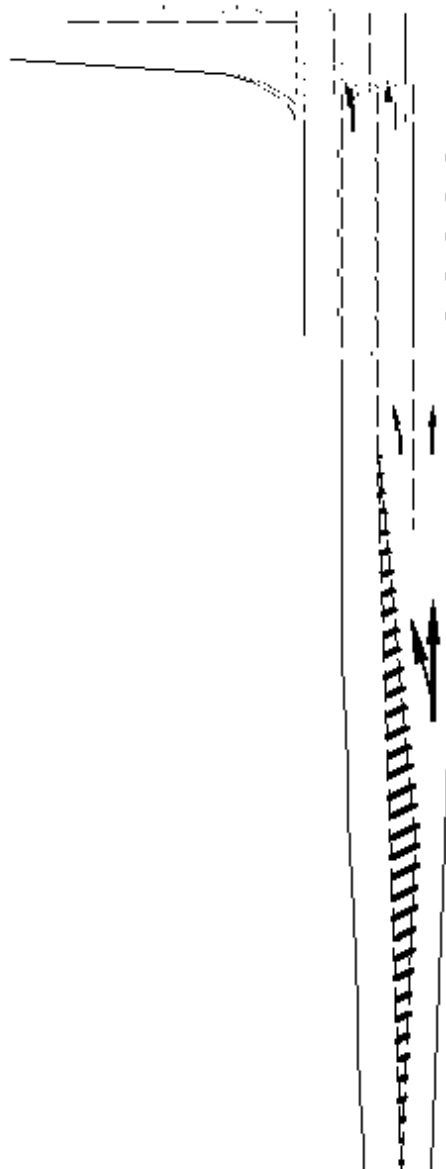


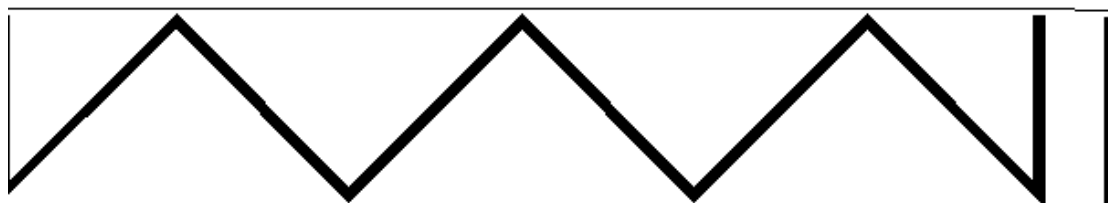


OFFICE OF THE ATTORNEY GENERAL

STATE OF CALIFORNIA

1





аграмма 27

Ди

